

# Grid Regular *design Jan Kočański, 2022*

S\_224 A  
224x99x80cm

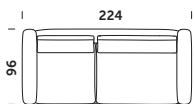

R\_01  
272x160x80cm

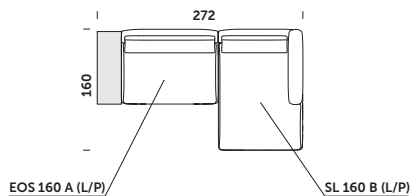

R\_05 A  
240x125x80cm

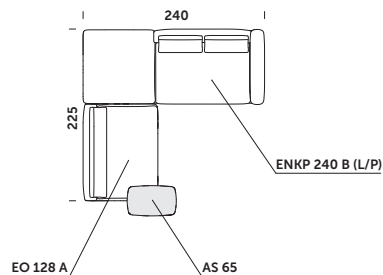

S\_240 B  
240x99x80cm

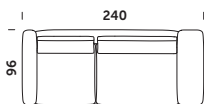

R\_02  
240x160x80cm

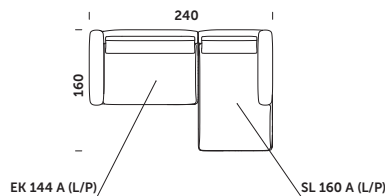

R\_05 B  
236x144x80cm

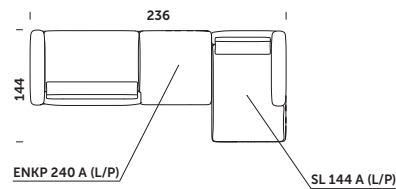

S\_256 B  
256x99x80cm

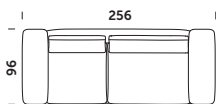

R\_03  
350x160x80cm

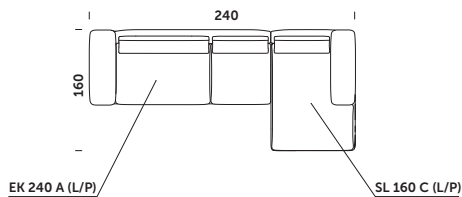

R\_06 A  
420x96x80cm

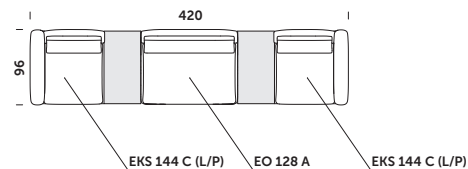

S\_272 A  
272x99x80cm

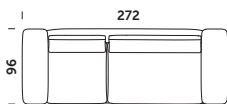

R\_04  
322x288x80cm

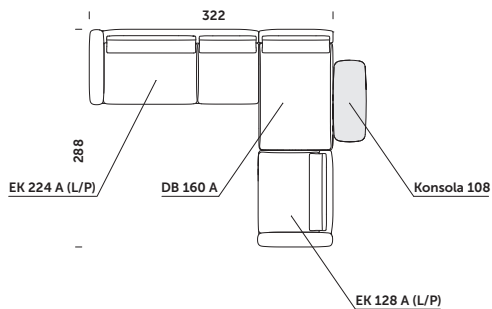

R\_06 B  
384x96x80cm

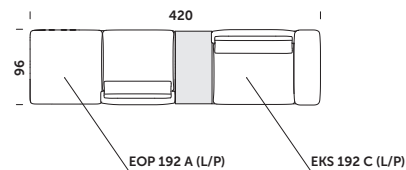

# Grid Regular *design Jan Kočański, 2022*

R\_06 C  
324x96x80cm

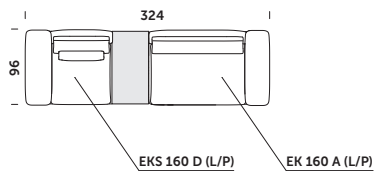

R\_06 G  
466x256x80cm

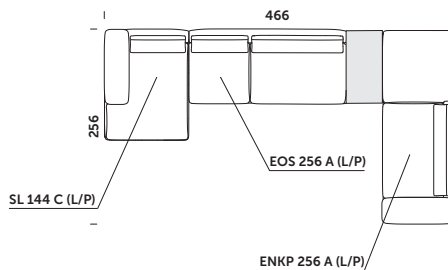

R\_06 D  
448x96x80cm

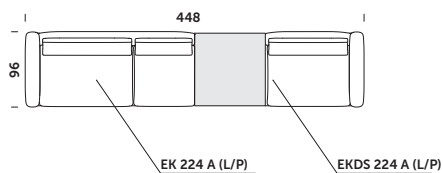

R\_06 H  
336x224x80cm

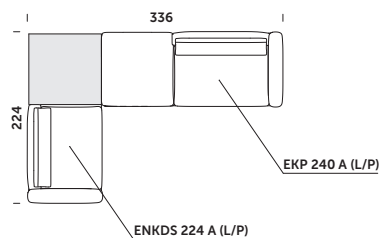

R\_06 E  
448x96x80cm

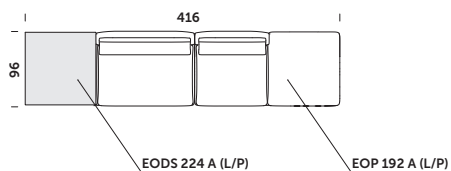

R\_06 I  
288x240x80cm

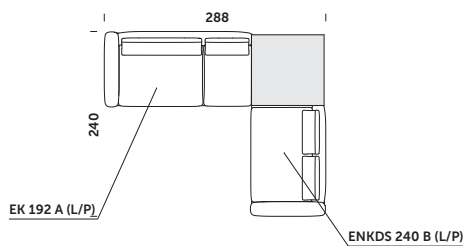

R\_06 F  
352x96x80cm

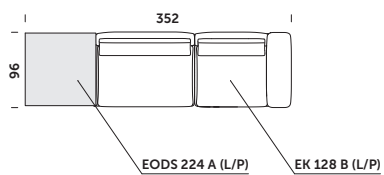

R\_06 J  
240x224x80cm

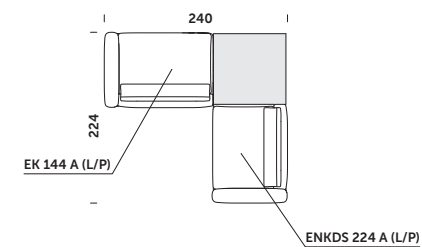

# Grid Regular *design Jan Kočański, 2022*

---

R\_06 K  
416x256x80cm

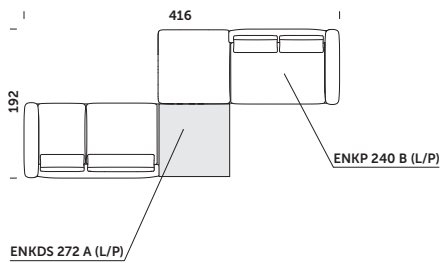

R\_06 L  
416x256x80cm

